

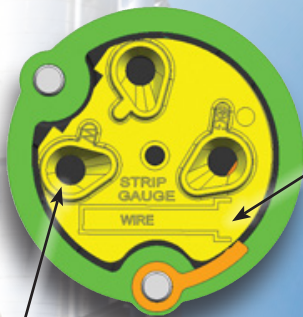

## EXCLUSIVE QUICK WIRING PLUG



UGPQW Plug



Built-in wire strip gauge

Wire guides enables easy conductor installation

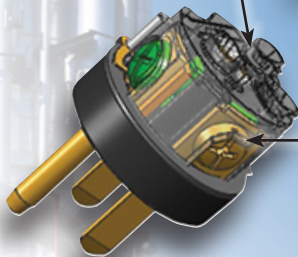

Side tightening terminals use full sized #2 screwdriver (either flat or Phillips)



Old style insulator requires miniature screwdriver

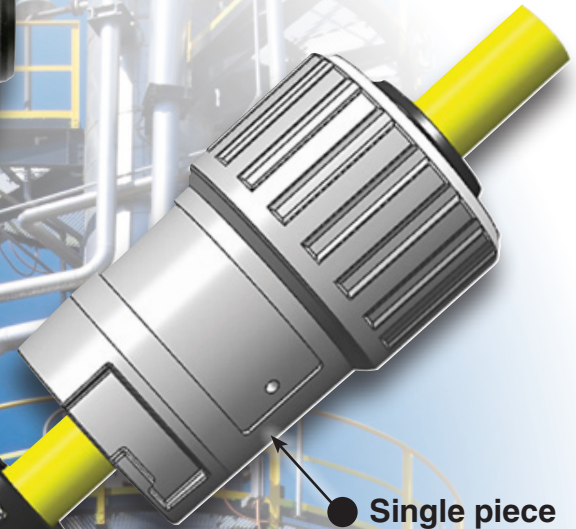

Single piece shell for fewer parts

Centered cable grip

Insulator fits one way only



# RECEPTACLES



## ACCEPTOR® SERIES

### UGR / UGP BLADED RECEPTACLES



UGR Receptacle



UGPQW Plug



**Class I, Div. 1 & 2, Groups B<sup>Ⓢ</sup>, C, D**  
**Class I, Zones 1 & 2, Groups IIB+H<sub>2</sub>, IIA**  
**Class II, Div. 1 & 2, Groups F, G**  
**Class III**  
**NEMA 3, 7 (B, C, D), 9 (F, G)**

**UL LISTED** File No. E91049 and/or E53660

**SP** Certified File No. LR14667

**Wire Size**

Suitable for 14-10 guage SOOW or similar cable

**FEATURES-SPECIFICATIONS**

## ACCEPTOR®

The ACCEPTOR® UGP/UGR Plug and Receptacle system, with its unique, patented design, is interchangeable<sup>①</sup> with other NEMA bladed type explosion-proof and dust ignition proof devices. The series has been tested and classified for use with Crouse-Hinds® Ark-Gard®2 and Appleton® U-Line® plugs and receptacles in hazardous locations. <sup>①</sup> **Now available in GFCI versions. See pages PR20-PR21**

**How The Acceptor System Works**

ACCEPTOR receptacles contain an integral switch which must be closed to energize the circuit. The design permits only an approved plug to be energized. To actuate the switch, the plug must be inserted and rotated clockwise approximately 45°. The plug will lock into this position preventing accidental disengagement. To remove, simply push in then turn the plug counterclockwise and pull straight out.

Plugs and receptacles may be used where interchangeable bladed devices are needed in locations made hazardous by the presence of flammable gases or vapors, combustible dusts or easily ignitable fibers and flyings.

Plug can serve to provide power for portable equipment used in both hazardous and non-hazardous areas.

**Applications**

- Petroleum Refineries, Chemical Plants
- Wet/Damp/Corrosive Areas
- Grain Elevators/Feed Mills

<sup>①</sup> Exact models classified for interchangeability are listed in the information sheet provided with the products. Ark-Gard® is a registered trademark of Crouse-Hinds®. U-Line® is a registered trademark of Appleton Electric Company®.

<sup>②</sup> Plugs Rated Group B when used with properly rated & installed receptacles. See next page.

**Features**

- All external hardware is 316 stainless steel to provide low maintenance and long life
- Factory sealed chamber in UGR receptacle contains switch's arcing components
- No additional external seals are required, except in Group B applications

**Quick Wiring Plug**

- Single piece shell for fewer parts
- Transparent wiring entrance holes for easy conductor insertion
- Screws tighten from side with "full sized" screwdriver (slot/Phillips)
- Insulator fits "one way"
- Centered cable grip



- Receptacles are U.L. Listed as raintight. Proper sealing against moisture is assured
- Spring loaded receptacle cover closes when plug is removed to provide protection when not in use
- Copper-free aluminum (less than 4/10 of 1%) alloy resists corrosion
- Electrostatically applied and baked powder epoxy/polyester finish

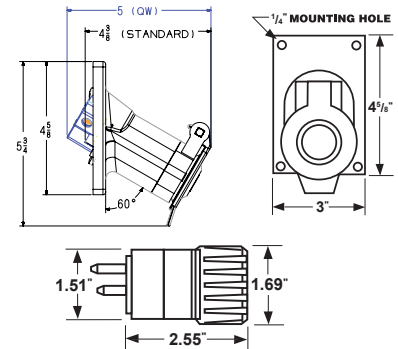

**PLUG**

ACCEPTOR® plugs conform to NEMA configurations and can be used with standard receptacles in non-hazardous areas to maximize equipment utilization. The system's "turn to engage" feature locks in

plug and can be used to prevent accidental disengagement of critical equipment.

Plugs for use with type S, SO, ST or STO heavy duty cord.

VOLTAGE	NEMA CONFIGURATION	CATALOG NUMBER	
		15 AMP PLUG W/QUICK WIRING*	20 AMP PLUG W/QUICK WIRING*
125VAC	 5-15P	UGP-15231QW	UGP-20231QW
250VAC	 6-15P	UGP-15232QW	UGP-20232QW
	 5-20P		
	 6-20P		

\*For Old Style plug remove QW from Catalog Number



## EXCLUSIVE QUICK WIRING RECEPTACLE

One or two conductors per phase

2nd conductor set feeds next receptacle in circuit

Wire Guides enable easy conductor insertion

Side tightening terminals use full sized #2 screwdriver (either flat or Phillips)

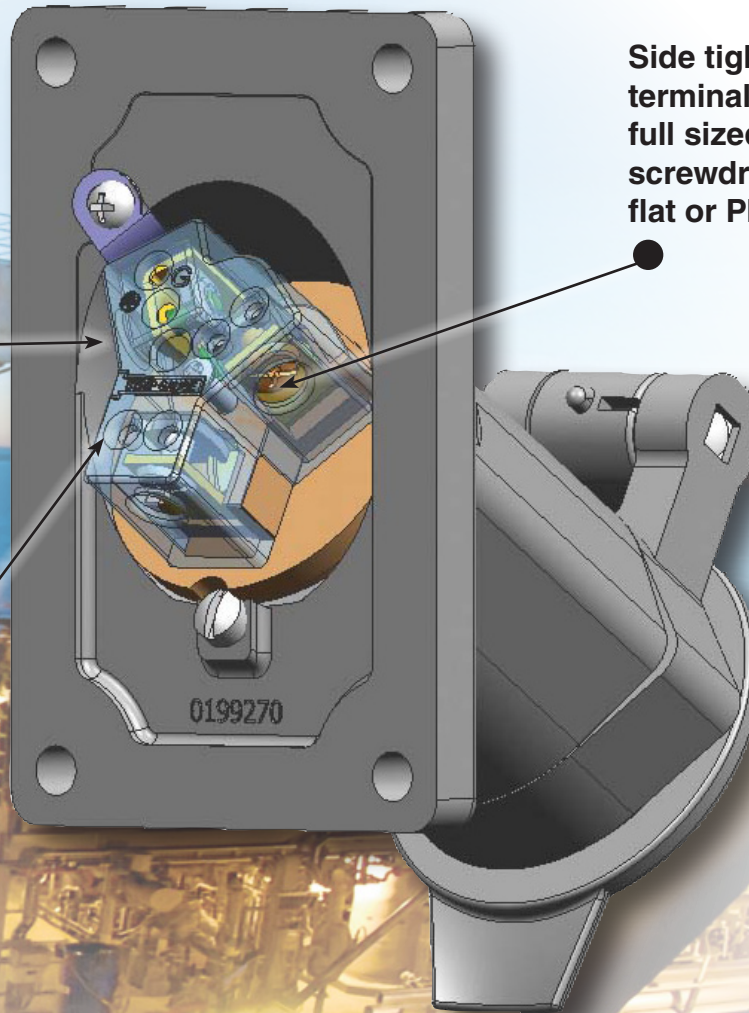

**Old Style Terminals**

- Recessed – Difficult to attach conductors
- Conductor must be curled – Full engagement uncertain
- Flat Screwdriver only
- Designed for one conductor – required jumper or “double wiring”

# RECEPTACLES



ACCEPTOR® SERIES

## UGRO QUICK WIRING SELECTION INFORMATION



SWB-1, 2, 3



SWB-4, 5, 6



Single Gang

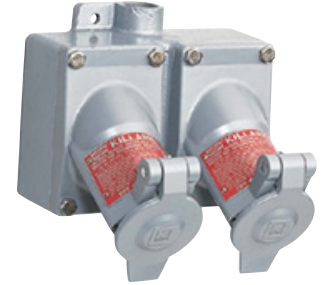

Double Gang

### FEATURES-SPECIFICATIONS

RECEPTACLES AND ASSEMBLIES <sup>④</sup>					
NEMA RATING & CONFIGURATION	ENCLOSURE STYLE	HUB SIZE	SINGLE GANG <sup>③④</sup> GROUPS C, D, F, & G*	DOUBLE GANG <sup>③④</sup> GROUPS C, D, F, & G*	SINGLE GANG <sup>①②</sup> GROUPS B, C, D, F & G*
 20 Amp 125 Volt 2 POLE 3 WIRE 5-20R	RECEPTACLE ONLY	—	UGR0-20231QW	UGR0-20231QW	—
	DEAD END	1/2"	UGR1-20231QW	UGR7-20231QW	UGRB1-20231QW
		3/4"	UGR2-20231QW	UGR8-20231QW	UGRB2-20231QW
		1"	UGR3-20231QW	UGR9-20231QW	UGRB3-20231QW
	FEED-THRU	1/2"	UGR4-20231QW	UGR10-20231QW	UGRB4-20231QW
		3/4"	UGR5-20231QW	UGR11-20231QW	UGRB5-20231QW
1"		UGR6-20231QW	UGR12-20231QW	UGRB6-20231QW	
 15 Amp 125 Volt 2 POLE 3 WIRE 5-15R	RECEPTACLE ONLY	—	UGR0C-15231QW	UGR0C-15231QW	—
	DEAD END	1/2"	UGR1C-15231QW	UGR7C-15231QW	UGRB1C-15231QW
		3/4"	UGR2C-15231QW	UGR8C-15231QW	UGRB2C-15231QW
		1"	UGR3C-15231QW	UGR9C-15231QW	UGRB3C-15231QW
	FEED-THRU	1/2"	UGR4C-15231QW	UGR10C-15231QW	UGRB4C-15231QW
		3/4"	UGR5C-15231QW	UGR11C-15231QW	UGRB5C-15231QW
1"		UGR6C-15231QW	UGR12C-15231QW	UGRB6C-15231QW	
 20 Amp 250 Volt 2 POLE 3 WIRE 6-20R	RECEPTACLE ONLY	—	UGR0-20232QW	UGR0-20232QW	—
	DEAD END	1/2"	UGR1-20232QW	UGR7-20232QW	UGRB1-20232QW
		3/4"	UGR2-20232QW	UGR8-20232QW	UGRB2-20232QW
		1"	UGR3-20232QW	UGR9-20232QW	UGRB3-20232QW
	FEED-THRU	1/2"	UGR4-20232QW	UGR10-20232QW	UGRB4-20232QW
		3/4"	UGR5-20232QW	UGR11-20232QW	UGRB5-20232QW
1"		UGR6-20232QW	UGR12-20232QW	UGRB6-20232QW	
 15 Amp 250 Volt 2 POLE 3 WIRE 6-15R	RECEPTACLE ONLY	—	UGR0C-15232QW	UGR0C-15232QW	—
	DEAD END	1/2"	UGR1C-15232QW	UGR7C-15232QW	UGRB1C-15232QW
		3/4"	UGR2C-15232QW	UGR8C-15232QW	UGRB2C-15232QW
		1"	UGR3C-15232QW	UGR9C-15232QW	UGRB3C-15232QW
	FEED-THRU	1/2"	UGR4C-15232QW	UGR10C-15232QW	UGRB4C-15232QW
		3/4"	UGR5C-15232QW	UGR11C-15232QW	UGRB5C-15232QW
1"		UGR6C-15232QW	UGR12C-15232QW	UGRB6C-15232QW	

① Items in this column are suitable for Class I, Group B in addition to Class I, Groups C, D. Also suitable for Class I, Zone 1, Groups IIB+H<sub>2</sub>, IIA.

② Seals must be installed within 6 inches of conduit opening.

③ Items in this column may also be used in Class I, Zone 1, Groups IIB, IIA. Assembly numbers not rated for Group B are shipped as receptacle & back box components.

④ Refer to Killark full-line catalog Section C for additional SWB Series Back Box configurations.

⑤ Canada only configuration

⑥ Canadian Codes now allow "T" combination slots for 15A or 20A plugs. Check breaker and wire feed size for proper application ratings.

NOTE: For replacement receptacle cover and hinge, order KIT-173. For dimension see PR15.

\* For Old Style plug remove QW from Catalog Number



## UGRC CONNECTORS

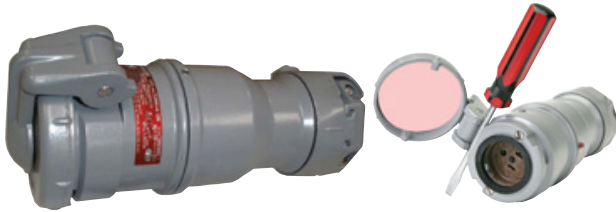

Connector with Breech-Lock Cap

“3rd Hand” Plug Operation

Class I, Div. 1 & 2, Groups B, C, D<sup>①</sup>  
 Class I, Zones 1 & 2, Groups IIB+H<sub>2</sub>, IIA<sup>①</sup>  
 Class II, Div. 1 & 2, Groups F, G<sup>②</sup>  
 Class III  
 NEMA 3, 4X\*

cSP<sup>®</sup> US Certified File No. LR14667 <sup>②</sup>  
 cSP<sup>®</sup> Certified File No. LR14667 <sup>①</sup>

**Wire Size**

Suitable for 14-10 guage SOOW or similar cable

**FEATURES-SPECIFICATIONS**

# ACCEPTOR®

**CONNECTORS**

The ACCEPTOR® UGRC Connector complements UGP/UGR Plugs and Receptacles, as well as Ground Fault Protected UGFI and UGRGF Models. Used with Acceptor plugs, connectors can extend the reach for hazardous location rated portable equipment such as hand lamps. Connectors eliminate the need for user-created corded box mounted receptacles. UGRC Connectors are interchangeable and classified for use with other NEMA bladed type explosion-proof and dust ignition proof plugs, including Crouse-Hinds® Ark-Gard®2 and Appleton® ULine®.

**Industrial Applications**

- Petroleum Refineries
- Chemical/Petrochemical Plants
- Oil Rigs & Platforms
- Wet/Corrosive Environments
- Grain Elevators

**Dimensions**

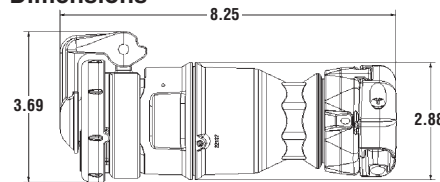

**UGRC Connector**  
 Breech cap model shown, Flip cap model dimensions are similar



Connector shown with Acceptor UGRP receptacle mounted in explosion proof Quantum® enclosure

**Features**

- Available with the exclusive Breech-Lock Cap (see PR5 for more info) – patented notch provides “3rd hand” plug operation (holds lid open while one hand operates plug, and other holds connector).
- Factory Sealed Construction
- Copper-free aluminum (less than 4/10 of 1%) alloy resists corrosion
- Electrostatically applied and baked powder epoxy/polyester finish
- Dead Front Construction with integral switch – requires Hazardous Rated NEMA Bladed plug for operation

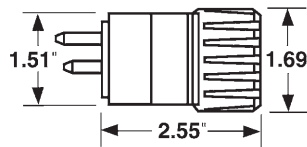

**UGP Plug**



**Flip Cap**

NEMA CONFIGURATION	125V CONNECTOR CAP STYLE	CATALOG NUMBER***	WEATHER RATING
20 Amp 125 Volt  2 POLE 3 WIRE 5-20R with T-slots	Breech-Lock with Notch Flip Type	UGRC-20231BQW <sup>③</sup> UGRC-20231FQW	N4X* N3**
	<b>Killark 125V Plugs</b> 20 Amp 15 Amp	<sup>③</sup> UGP-20231QW UGP-15231QW	
<b>250V CONNECTOR CAP STYLE</b>			
20 Amp 250 Volt  2 POLE 3 WIRE 6-20R with T-slots	Breech-Lock with Notch Flip Type	UGRC-20232BQW UGRC-20232FQW	N4X* N3**
	<b>Killark 250V Plugs</b> 20 Amp 15 Amp	<sup>③</sup> UGP-20232QW UGP-15232QW	

\* Breech cap models N4X with lid closed and turned, N3 When Plug inserted Hinge Up (see page PR3)

\*\* Flip Lid models N3 with hinge in UP position with or without plug

Replacement Cap and Hinge Kits: Breech KIT-173B, Flip KIT-173

① CSA certified Class I Div.1 for Canada and/or other jurisdictions accepting CSA.

② cCSA<sub>US</sub> Class II, Groups F & G for US and Canada.

③ Remove QW in catalog number for Standard Wiring type plug.

④ 125V 15A only (no T-slot) receptacles are available. See 5-15R Canadian configuration page PR17.  
 Order numbers UGRC-15231B or UGRC-15231F.

\*\*\* For Old Style plug remove QW from Catalog Number

Ark-Gard® is a registered trademark of Crouse-Hinds®  
 U-Line® is a registered trademark of Appleton Electric Company®

# RECEPTACLES

## ACCEPTOR® SERIES



### UGRP PANEL RECEPTACLES



Breach Cap Model



Flip Cap



Typical Installation

Class I, Div. 1 & 2, Groups B, C, D<sup>①</sup>  
 Class I, Zones 1 & 2, Groups IIB+H<sub>2</sub>, IIA  
 Class II, Div. 1 & 2, Groups F, G  
 Class III  
 NEMA 3, 4X\*

Certified File No. LR14667<sup>②</sup>

**Wire Size**

Suitable for 14-10 gauge SOOW or similar cable

**FEATURES-SPECIFICATIONS**

## ACCEPTOR®

### PANEL RECEPTACLES

The ACCEPTOR® UGRP Panel Receptacle complements UGP/UGR Plugs and Receptacles, as well as Ground Fault Protected UGFI and UGRGF Models.

Used with Acceptor plugs, panel receptacles provide local power for hazardous location rated portable equipment such as hand lamps. Units are suitable for Class I Div. 1 or Class I Div.2 depending on the enclosure type used<sup>①</sup>.

UGRP Panel Receptacles are interchangeable and classified for use with other NEMA bladed type explosion-proof and dust ignition proof plugs, including Crouse-Hinds® Ark-Gard®2 and Appleton® ULine®.

**Features**

- Available with the exclusive **Breach-Lock Cap** (see PR5 for more info) – patented notch provides “3rd hand” plug operation (holds lid open while one hand operates plug, and other holds connector).
- Factory Sealed Construction
- Copper-free aluminum (less than 4/10 of 1%) alloy resists corrosion
- Electrostatically applied and baked powder epoxy/polyester finish
- Dead Front Construction with integral switch – requires Hazardous Rated NEMA Bladed plug for operation

*Ark-Gard® is a registered trademark of Crouse-Hinds®  
 U-Line® is a registered trademark of Appleton Electric Company®*

**Industrial Applications**

- Petroleum Refineries
- Chemical/Petrochemical Plants
- Oil Rigs & Platforms
- Wet/Corrosive Environments
- Grain Elevators

- UGRP Receptacles are available “Factory Installed” in the following series:  
**Enclosures**  
 » Series EXB, B7E  
**Distribution Equipment**  
 » Series D2L, B7L Lighting Panelboards  
 • Contact factory for ordering information



Breach Lid



Flip Cap

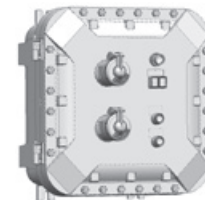

Typical CLI Div. 1 application

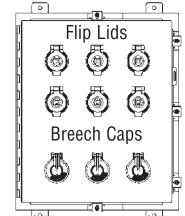

Typical CLI Div. 2 application  
 2-3/8" K.O.

**Dimensions**

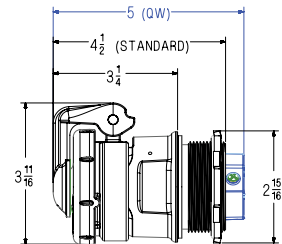

Breach Cap model shown.  
 Flip Cap model dimensions are similar

NEMA CONFIGURATION	125V PANEL RECEPTACLE CAP STYLE	CATALOG NUMBER****	WEATHER RATING
 20 Amp 125 Volt 2 POLE 3 WIRE 5-20R with T-slots	Breach-Lock with Notch Flip Type	UGRP-20231BQW UGRP-20231FQW <sup>④</sup>	N4X* N3**
	Killark 125V Plugs 20 Amp 15 Amp	<sup>③</sup> UGP-20231QW UGP-15231QW	
250V PANEL RECEPTACLE CAP STYLE			
 20 Amp 250 Volt 2 POLE 3 WIRE 6-20R with T-slots	Breach-Lock with Notch Flip Type	UGRP-20232BQW UGRP-20232FQW	N4X* N3**
	Killark 250V Plugs***	<sup>③</sup> UGP-20232QW UGP-15232QW	

\* Breach cap models N4X with lid closed and turned, N3 When Plug inserted Hinge Up  
 \*\* Flip Lid models N3 with hinge in UP position with or without plug  
 \*\*\* See PR17 for Plug NEMA Diagram and Dimensions  
 Replacement Cap and Hinge Kits: Breach KIT-173B, Flip KIT-173  
<sup>①</sup> Class I Div.1 B,C,D in enclosures certified to 325 explosive PSI (2"-1 1/2" NPSM threads). Class I Div. 2 in standard location enclosures using only non-arcing components.  
<sup>②</sup> Certified for United States, Canada, and other jurisdictions accepting the mark.  
<sup>③</sup> Remove QW in catalog number for Standard Wiring type plug.  
<sup>④</sup> 125V 15A only (no T-slot) receptacles are available. See 5-15R Canadian configuration page PR17.  
 Order numbers UGRP-15231B or UGRP-15231F.  
 \*\*\*\* For Old Style plug remove QW from Catalog Number



## UGRS / UGRGF RECEPTACLES

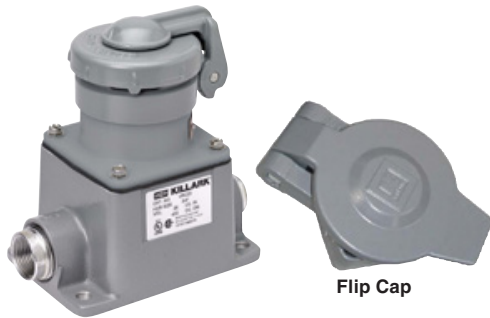

Breach Cap Model

Flip Cap

**Class I, Div. 2, Groups B, C, D**  
**Class I, Zone 2, Groups IIB+H<sub>2</sub>, IIA**  
**Class II, Div. 1 & 2, Groups F, G**  
**Class III**  
**NEMA 3, 4X**

Certified File No. LR14667③



UGRGF

**Class I, Div. 1 & 2, Groups C, D**  
**Class I, Zones 1 & 2, Groups IIB, IIA**  
**Class II, Div. 1 & 2, Groups F, G**  
**Class III**  
**NEMA 3, 7 (C, D) 9 (F, G)**

Certified LR11714  
 See files for details or call Killark.

### GFI PROTECTED RECEPTACLE

Utilizes FXS GFI and ACCEPTOR® receptacle to interrupt a circuit, when a ground fault is detected on equipment which may be handled by personnel in hazardous locations.

### Features

- Factory Sealed
- Test and Reset push buttons are provided on cover assembly, with optional pilot light available④ Unit should be tested monthly
- Includes new GFCI to meet latest UL943 GFCI standards revisions
- Exterior gasket provides NEMA 3 weatherproof protection
- Ground boss for grounding in the splice box
- Color coded wiring and stainless steel cover bolts
- Receptacle used is UGRO-20231. See page PR17

NEMA RATING & CONFIGURATION	ENCLOSURE STYLE	HUB SIZE	CATALOG NUMBER
20A, 125V, 2P, 3W	Dead End	1/2"	UGRGF107
	Dead End	3/4"	UGRGF108
	Dead End	1"	UGRGF109
	Feed Thru	1/2"	UGRGF110
	Feed Thru	3/4"	UGRGF111
	Feed Thru	1"	UGRGF112

### Electrical Rating

GFI units are rated at 20A, 120 VAC, 60Hz. Class A.

4-6 milliamp trip setting  
 Trip Time-UL Curve

④ For Red LED pilot light indicator of live circuit, add "-PL" to catalog number. Example - UGRGF107-PL.

### FEATURES-SPECIFICATIONS

## ACCEPTOR® SQUARE RECEPTACLE

UGRS Receptacles utilize VERSAMATE® 30A mounting boxes and are designed to provide "ROTATABLE" design enables cover hinge location to be in most convenient position for application. May also be utilized with sheet metal enclosures which contain no arcing devices.

### Dimensions

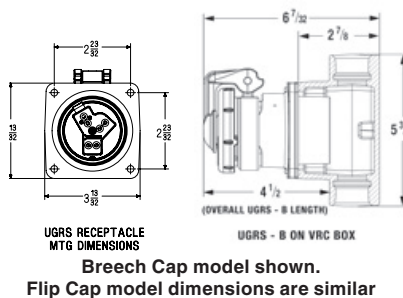

NEMA CONFIGURATION	125V SQUARE RECEPTACLE CAP STYLE	CATALOG NUMBER
20 Amp 125 Volt 2 POLE 3 WIRE 5-20R with T-slots	Breach-Lock with Notch* Flip Lid Type**	UGRS-20231BQW④ UGRS-20231FQW
	Killark 125V Plugs*** 20 Amp 15 Amp	UGP-20231QW UGP-15231QW
250V SQUARE RECEPTACLE CAP STYLE		
20 Amp 250 Volt 2 POLE 3 WIRE 6-20R with T-slots	Breach-Lock with Notch* Flip Lid Type**	UGRS-20232BQW UGRS-20232FQW
	Killark 250V Plugs*** 20 Amp 15 Amp	UGP-20232QW UGP-15232QW

\* Breach cap models N4X with lid closed and turned, N3 When Plug inserted Hinge Up

\*\* Flip Lid models N3 with hinge in UP position with or without plug

\*\*\* See PR15 for Plug NEMA Diagram and Dimensions

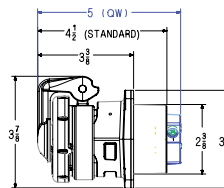
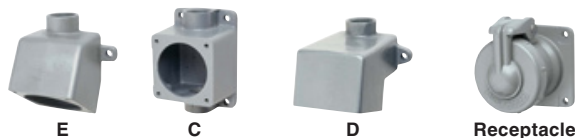

UGRS RECEPTACLE & BACKBOXES ①				
	E TYPE DEAD END ②	C TYPE FEED THRU ②	D TYPE ANGLED FEED THRU ③	RECEPTACLE ONLY
20A 125V	UGRS-20231BE2QW	UGRS-20231BC2QW	UGRS-20231BD2QW	UGRS-20231BQW
20A 250V	UGRS-20232BE3QW	UGRS-20232BC3QW	UGRS-20232BD3QW	UGRS-20232BQW

① Receptacles listed are with Breach cap; for Flip Cover change B to F.  
 ② Boxes listed are for 3/4"; for 1/2" change last digit to 1, for 1" change last digit to 3.  
 ③ cCSA<sub>us</sub> Certified for United States, Canada, and other jurisdictions accepting the mark.  
 ④ 125V 15A only (no T-slot) receptacles are available. See 5-15R Canadian configuration page PR17.  
 Order numbers UGRS-15231BQW or UGRS-15231FQW.  
 \*\*\* For Old Style plug remove QW from Catalog Number

# RECEPTACLES



## ACCEPTOR® SERIES

### UGFI GROUND FAULT PROTECTOR

# ACCEPTOR®



Adapter Unit

The GFCI protected ACCEPTOR® is the solution to OSHA's requirements for GFCI protection when using portable equipment in hazardous and wet locations. For use with 125V, or 125/250V<sup>②</sup> 15 or 20 amp receptacles without GFCI protection, the **Adapter Unit** provides GFCI and circuit protection to connected apparatus by simply being plugged into an existing receptacle.

The **Hard-Wired Unit** provides the same protection and is used directly as a GFCI protected device. Units are feed-through with one close-up plug.

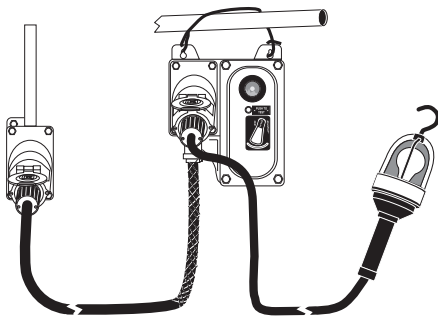

Typical Application with XHL Series Hand Lamp

UL LISTED File No. E91049<sup>②</sup>

CSA US Certified File No. LR14667<sup>②</sup>

### FEATURES-SPECIFICATIONS

#### Adapter Unit

- No need to permanently alter existing installations; **Portable Unit** can be temporarily hung using included strap near an existing receptacle wherever protection is required
- Factory Sealed Unit
- Acceptor® plug and cord set included with **Adapter Unit**. Cord is 36"

#### Hard-Wired Unit

- provides GFCI and circuit protection in new installations, or as an upgrade or replacement for non-GFCI receptacles
- Factory Sealed, except Group B

#### Adapter and Hard-Wired Unit

- GFCI device also provides circuit protection, for connected apparatus, against current overload and short circuits
- Acceptor® receptacles and plugs are interchangeable with both Crouse-Hinds® Ark-Gard®<sup>②</sup> and Appleton® U-Line® products
- Amber pilot light provides indication that the receptacle is energized.
- Units can be Padlocked OFF for maintained safety
- Fully gasketed GFCI compartment prevents moisture from damaging electronic components
- Same high quality materials as the standard ACCEPTOR®

- ① Hard-Wired assemblies in Group B areas require sealing within 6" of enclosure.
- ② 125VAC & 250 VAC devices are CCSAUS certified; 125VAC devices are also UL Listed.
- ③ 2P 250V units are for 2 "hot line" applications and include 2P 5mA GFI breakers. 2P Units are for 120/240V or 120/208Y Grounded Power Supply Systems ONLY. **Do NOT use with Delta supply systems.**

Ark-Gard® is a registered trademark of Crouse-Hinds®  
U-Line® is a registered trademark of Appleton Electric Company®.

- **Adapter Unit**  
Class I, Div. 2, Groups B, C, D  
Class I, Zone 2, Groups IIB+H<sub>2</sub>, IIA  
Class II, Div. 1 & 2, Groups F, G  
Class III, Div. 1 & 2
- **Hard-Wired Unit**  
Class I, Div. 1 & 2, Groups B, C, D  
Class I, Zones 1 & 2, Groups IIB+H<sub>2</sub>, IIA  
Class II, Div. 1 & 2, Groups F, G  
Class III, Div. 1 & 2

**NEMA 3 ENCLOSURE TYPE**  
(Adapter or Hard-Wired units)

#### GFCI RECEPTACLE ADAPTER (W/CORD SET)

20A 125V ②	UGFI20AD	 5-20R
15A 125V ②	UGFI15AD	 5-15R
20A 250V ②③	UGFI202AD	 6-20R
15A 250V ②③	UGFI152AD	 6-15R

#### HARD WIRED (PERMANENTLY MOUNTED) GFCI RECEPTACLE

20A 125V ②	 5-20R	1/2" HUB 3/4" HUB 1" HUB	UGFI20C1 UGFI20C2 UGFI20C3
15A 125V ②	 5-15R	1/2" HUB 3/4" HUB 1" HUB	UGFI15C1 UGFI15C2 UGFI15C3
20A 250V ②③	 6-20R	1/2" HUB 3/4" HUB 1" HUB	UGFI202C1 UGFI202C2 UGFI202C3
15A 250V ②③	 6-15R	1/2" HUB 3/4" HUB 1" HUB	UGFI152C1 UGFI152C2 UGFI152C3

#### Hard-Wired Unit

